



## DYNACO D-313 EMERGENCY

**Gravity  
driven**

low friction technology



inside door

[www.dynacodoor.com](http://www.dynacodoor.com)

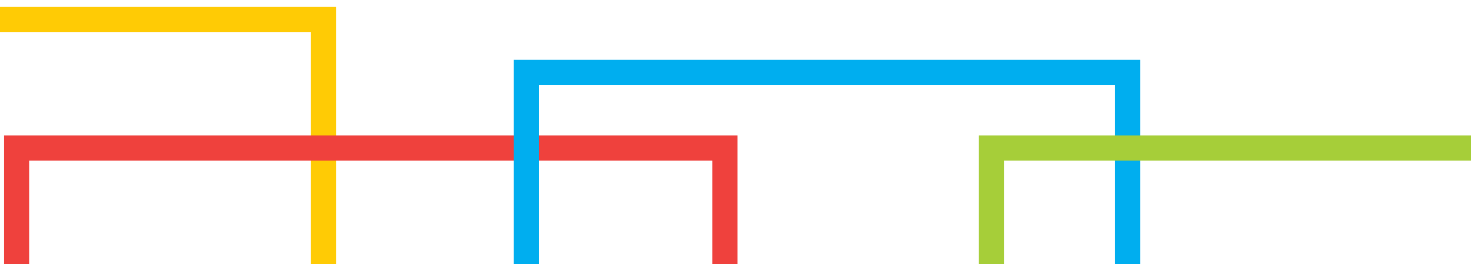

# DYNACO D-313 EMERGENCY

The Dynaco D-313 Emergency is designed as an emergency exit for inside applications. At the same time, it offers all the advantages of a Dynaco high speed door. With its modern design, the D-313 Emergency LF is the slimmest high speed door in the market.

The smooth operation and the low maintenance requirements make it a perfect door for retail stores. An ingenious T-shaped cut in the middle of the curtain allows two symmetric “flaps” to release an emergency exit, simply by pushing on the indicated spot.

- **OPENING SPEED:**  
Up to 2 m/s
- **GOOD SEAL:**  
Patented side guides and «BEAD» technology allow energy savings.
- **MINIMAL SPACE, MODERN LOOK:**  
Motor installed inside the drum (DVDM<sup>PT</sup>).  
Very aesthetic design.
- **USER SAFETY:**  
Flexible curtain without rigid elements.  
Integrated emergency escape system.
- **COMFORT OF USE:**  
DYNACO wireless detector at the bottom.
- **ADVANCED DRIVE:**  
Frequency driven motor and encoder for smooth operation. Wearable elements are reduced to a minimum.
- **DYNALOGIC CONTROL BOX:**  
User-friendly control box with self-diagnosis.
- **CONFORM TO EN13241-1**

Opening by pushing at the emergency release spots



Incorporated Motor



# Gravity driven

low friction technology



























inside door

## EN13241-1 STANDARDS

Standard	Ref.	Test acc.	Results
<b>Water permeability</b>	EN 12425	EN 12489	Class 1
<b>Wind load</b>	EN 12424	EN 12444	Class 1*
<b>Wind permeability</b>	EN 12426	EN 12427	Class 0
<b>Safe openings</b>	EN 12453	EN 12445	Pass
<b>Mechanical resistance</b>	EN 12604	EN 12605	Pass
<b>Unintended movements</b>	EN 12604	EN 12605	Pass
<b>Thermal resistance</b>	EN 12428	EN 12428	6,02 W/m <sup>2</sup> K
<b>Performance (cycles)</b>	EN 12604	EN 12605	1.000.000

\* Interior applications only.

## CHARACTERISTICS

<b>Max. dimensions</b>	W 3.500 mm x H 3.500 mm																
<b>Min. dimensions</b>	W 900 mm x H 2.200 mm																
<b>Opening speed</b> <b>Closing speed</b>	up to 2,0 m/s 0,5 m/s																
<b>Structure</b>	Galvanised steel of 37 x 52 x 3 mm. Option: stainless steel.																
<b>Covers</b>	Synthetic material, colour aluminium + black. Full covers standard.																
<b>Drum</b>	PVC - Ø 200 x 3,9 mm.																
<b>Side guides</b>	Reinforced polyethylene (PE-UHMW1000)																
<b>Motor</b>	2 poles, with parking brake. Power 0,75 kW IP rating: IP 55																
<b>Control box</b>	DYNALOGIC provided with: Circuit breaker, general divider, adjustable timer, push button for opening and reset and emergency stop. IP rating: IP 54. Frequency inverter.																
<b>Standard detectors</b>	Infrared barrier: 300 mm from the floor. Wireless DYNACO detector (WDD). DBD: correct unwinding detector.																
<b>Power supply</b> <b>Frequency</b>	Single phase 230V - 18 A Frequency: 50-60 Hz																
<b>Advised operating temperature:</b>	+ 5°C up to +40°C																
<b>Available colours</b> comparable with:	<table border="0"> <tr> <td>Yellow RAL1003</td> <td></td> <td>Green RAL6005</td> <td></td> </tr> <tr> <td>Orange RAL2004</td> <td></td> <td>Grey RAL7035</td> <td></td> </tr> <tr> <td>Red RAL3000</td> <td></td> <td>White RAL9010</td> <td></td> </tr> <tr> <td>Blue RAL5002</td> <td></td> <td>Black RAL9005</td> <td></td> </tr> </table>	Yellow RAL1003		Green RAL6005		Orange RAL2004		Grey RAL7035		Red RAL3000		White RAL9010		Blue RAL5002		Black RAL9005	
Yellow RAL1003		Green RAL6005															
Orange RAL2004		Grey RAL7035															
Red RAL3000		White RAL9010															
Blue RAL5002		Black RAL9005															
(Actual colours may deviate. Colour samples available upon request)																	

## Low friction side guides

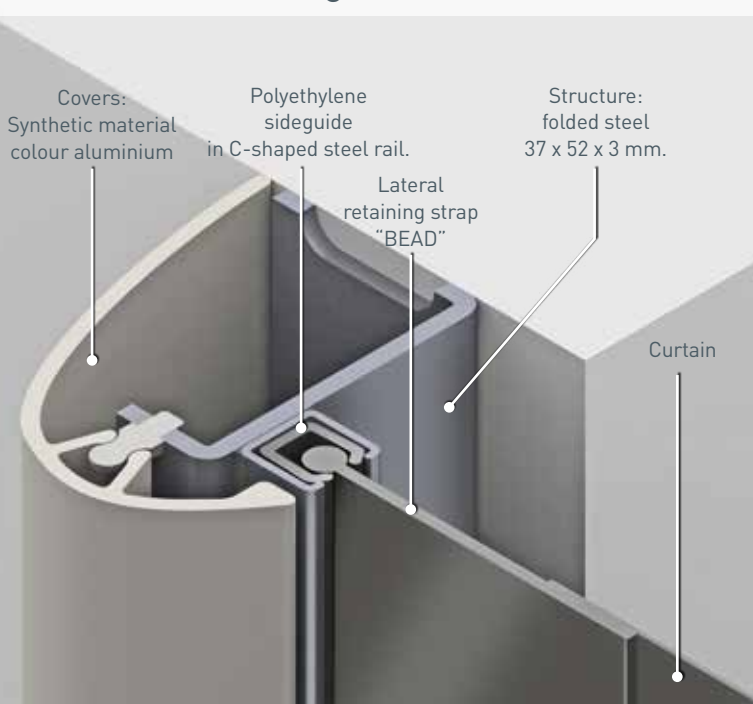

## Reintroduction block<sup>PT</sup>



## Dimensions and installation requirements Dynaco D-313 Emergency

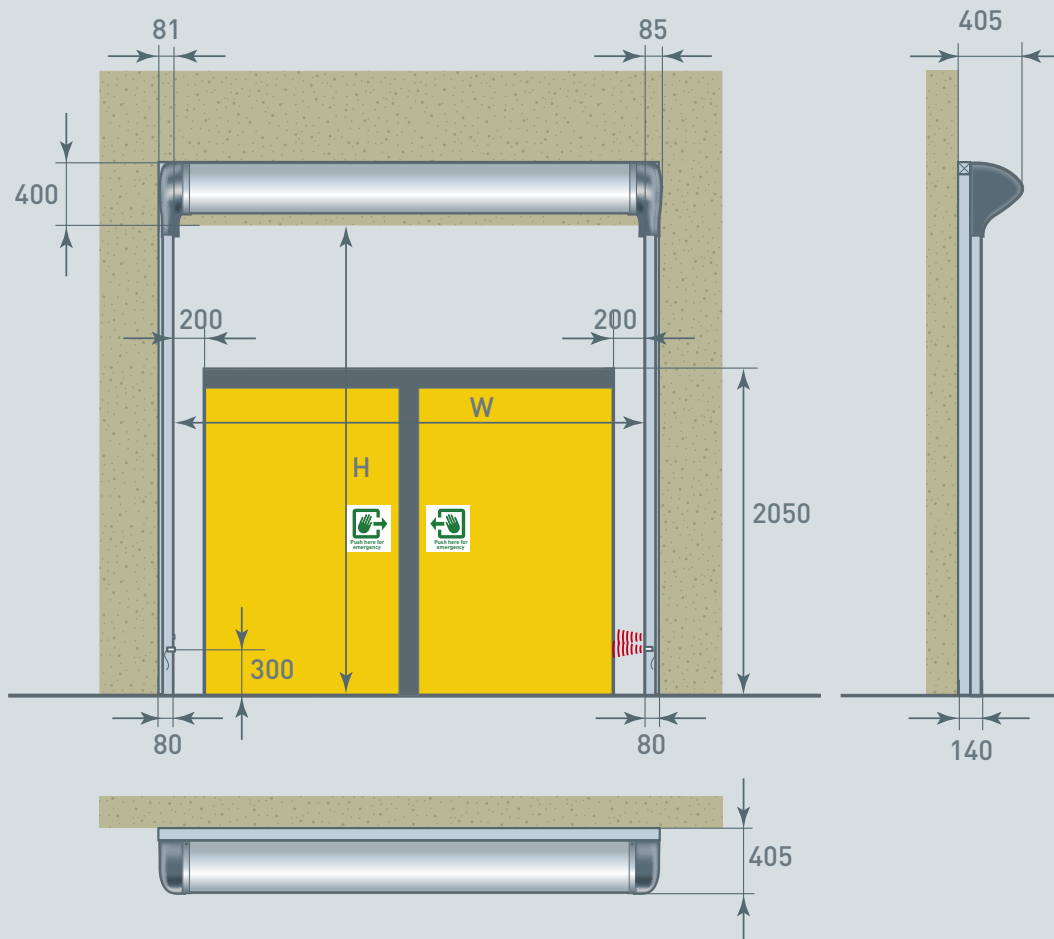

All indicated dimensions are based on exact width and height dimensions only.  
The space necessary for mounting and maintenance has to be provided.

REMARK: Based on the risk analysis of the environment, extra push buttons, detectors and covers might be required.

© Entrematic Group AB – 2016

Entrematic offers a comprehensive range of products for industrial, commercial, institutional and residential applications, including sectional doors, loading dock equipment, high-performance doors, residential garage doors, pedestrian doors, gates and barriers, and automation and operators. Built on nearly 200 years of accumulated expertise, Entrematic aims to be the most dynamic, innovative company in the entrance automation industry, and the best partner for dealers and installers. Our well-known brands include Normstahl, Dynaco, Ditec and EM.

Entrematic, Amarr, Kelly, Serco, Normstahl, Dynaco, Ditec and EM, as words and logotypes, are examples of trademarks owned by Entrematic Group AB or companies within the Entrematic Group.

The Dynaco products are protected by worldwide registered patents. As part of its policy of continuous product development, Entrematic Belgium NV reserves the right to change the characteristics of its products or components without prior notice.

Disclaimers:

For a correct use of our products, please refer to our manual. Everything that is mentioned in this brochure is only valid under the terms of use in the user manual and on condition that the door was properly installed and maintained and has not undergone abuse nor neglect.

ENTREMATIc BELGIUM NV  
Waverstraat 21  
B-9310 Moorsel-Aalst (Belgium)  
Tel. +32 53 72 98 98  
Fax. +32 53 72 98 50  
info.dynaco.eu@entrematic.com  
www.dynacodoor.com

**ENTREMATIc**